



**SWIFT**

# 2025 Motorhomes



Your Home Anywhere







# Welcome to Swift

# UK's No.1 brand for leisure vehicles

We are the UK's largest leisure vehicle manufacturer producing touring caravans, motorhomes, campervans and holiday homes.

We've grown from simple foundations back in 1964, when our founder Ken Smith built his first touring caravan, to become the UK's number one leisure vehicle brand.

Our philosophy is to build leisure vehicles that are at the heart of your holiday, whether that be nestled in the countryside or by the sea, searching out active pursuits or simply enjoying a quieter pace of life. With a lifetime of memories waiting to be made, it's time to find your ultimate motorhome.



## Contents

The Swift Difference	<b>4</b>	Fabrics at a glance	<b>26</b>
SMART Construction	<b>6</b>	Specification at a glance	<b>28</b>
Ascari	<b>8</b>	Bed sizes at a glance	<b>30</b>
Voyager	<b>12</b>	Swift Go	<b>31</b>
Escape	<b>16</b>	Swift Command	<b>32</b>
Kon-Tiki	<b>20</b>	My Swift Life	<b>34</b>
Layouts at a glance	<b>24</b>	Swift Owners Clubs	<b>35</b>

# Introducing The Swift Difference

There's no better feeling than stepping into your motorhome for a relaxing getaway. We've dedicated countless hours of research and development to ensure that every detail of your motorhome is built to last and luxuriously comfortable, so you can get on with the important things in life – creating memories and enjoying unforgettable holidays.

Only when you choose Swift can you enjoy this exclusive package of benefits, as part of our Swift Difference.

**Check out our guides,  
articles and features!**

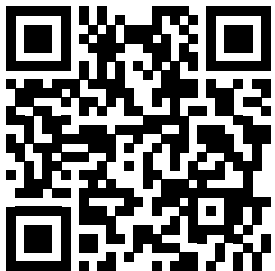

## SMART construction

The UK's leading modern construction system with 'PURE' timberless framing that's impervious to water.\*

\*Coachbuilt motorhomes only



## Efficient living

Swift motorhomes are engineered with efficiency at its core - from aerodynamic exteriors to low energy LED lighting and dual fuel systems to onboard water tanks.



## Long term warranties

Extra reassurance with multiple warranties including an industry leading 10 year bodyshell warranty on coachbuilt motorhomes.\*

\*Terms and Conditions apply





## Supreme comfort

Enjoy an exceptional night's sleep with a Duvalay mattress fitted to all fixed and drop down beds and exclusive to Swift.



## Expert training

Launched in 2015, The Swift Academy provides our employees with the opportunity to develop their skills at every stage of their career, encouraging our employees to reach their full potential. We have invested in the Swift Academy because we believe in our people and want to demonstrate our commitment to their development.



## All year freedom

Swift motorhomes are tested to the extreme in a cold chamber to ensure they achieve the Grade 3 thermal insulation rating. The internal temperature can be maintained at 20°C while the external temperature is as low as -15°C, so you can stay warm and comfortable whatever the weather.



## Extensive choice

With over twenty models across our four motorhome ranges, there is a huge choice to suit most budgets and tastes – and all supported by the UK's largest dealer network. A large proportion of Swift Motorhomes can also be driven with a standard driving licence.



## My Swift Life

My Swift Life provides owners with a unique personal profile, where you can access information that's specific to your caravan, campervan or motorhome, including; outstanding warranty claims, service information and a direct line into our Swift customer experience team.



## Pioneers

Innovation is our passion. We continually push the boundaries and utilise state-of-the-art design and construction techniques to ensure our products look sensational, work intuitively and function efficiently. Swift Command\*, a product of innovative thinking, monitors and controls onboard systems via a user-friendly panel and smartphone app.

\*Range specific



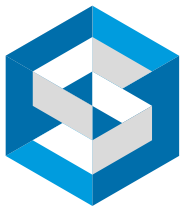

**SWIFT**

**SMART**

# Standing the test of time with **Smart Construction**

As the trailblazer in the leisure vehicle industry, we have consistently raised the bar with our unwavering commitment to research and innovation.

Providing you with peace of mind, SMART is an ingenious blend of materials and construction techniques that guarantee enhanced structural integrity, improved insulation and all-important weather resistance - ensuring your investment will stand the tests of touring and help retain your motorhome's residual value.



## **Strong**

The strong timberless body frame uses 'PURE', a tough, hard polyurethane based product, that is totally impervious to water and has been proven through use.



## **Modern**

SMART uses modern materials produced using cutting-edge technology and has been developed to ensure the exterior profiles maintain the modern desirable looks our coachbuilt motorhomes are renowned for.



## **Aerodynamic**

We continue to lead the way in aerodynamics using Computational Fluid Dynamics to help shape the bodyshell for better fuel consumption and safer towing.



## **Resilient**

All sides, roofs and rears of our coachbuilt motorhomes have outer and inner GRP skins. GRP is more impact resistant than aluminium and can be easily repaired, ensuring long lasting good looks, securing your investment for the future.



## **Tested**

Extensive safety and durability testing at the Millbrook track, and cold chamber testing down to minus 15°C and beyond puts prototypes through conditions most products will never have to experience in a lifetime.



## PURe Polyurethane framework

The strong timberless body frame uses 'PURe', a tough, hard polyurethane based product that is totally impervious to water, ensuring the longevity of your motorhome.

## Polystyrene core

For ensured accuracy, lightweight polystyrene is cut to shape using the latest water jet technology. With 28mm polystyrene used in the side walls and roof, all Swift motorhomes meet the Grade 3 thermal properties needed for year-round adventures.

## GRP

Manufactured at Swift, our GRP (glass reinforced plastic) front and rear panels are robust and resilient. The side panels feature outer and inner GRP skins of the same thickness to create a balanced panel which allows the motorhome to expand and contract in different climatic conditions.

Unlike other manufacturers, our GRP inner skin does not use any jointing tape - all Swift motorhomes have a jointless sealing in the walls, and are embellished with wallpaper finishes.

## Roof

The outer layer of the hail-resistant roof is fully bonded with woven white GRP. All Swift coachbuilt motorhomes are built with increased roof strength to allow for any additional features including air conditioning and satellite dishes (model specific).

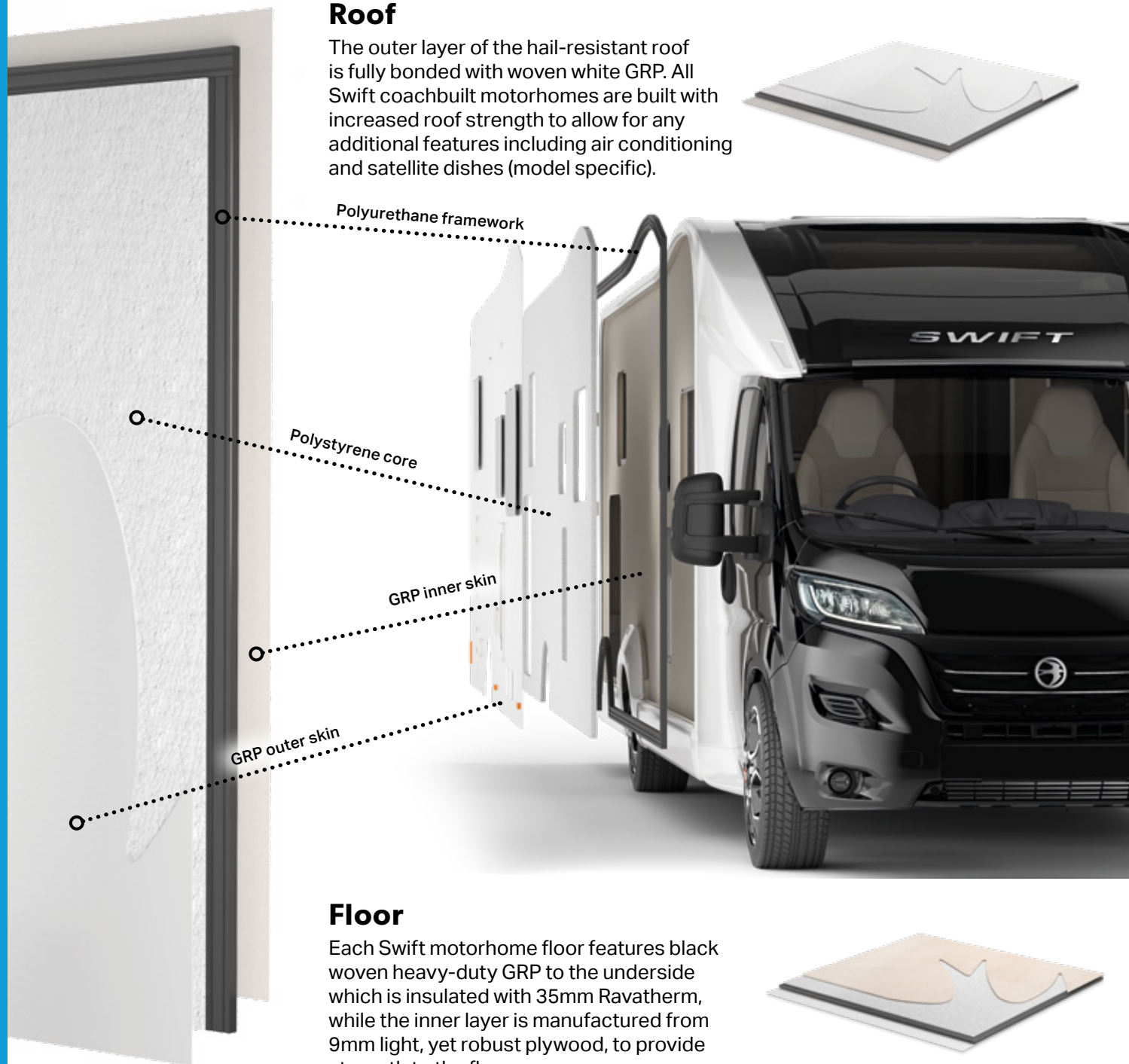
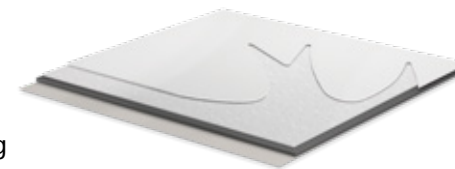

## Floor

Each Swift motorhome floor features black woven heavy-duty GRP to the underside which is insulated with 35mm Ravatherm, while the inner layer is manufactured from 9mm light, yet robust plywood, to provide strength to the floor.

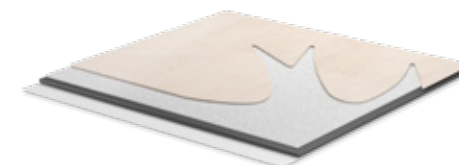





# Introducing Ascari

The Ascari is a narrow coachbuilt motorhome. Streamlined and nimble, it's similar in size to a panel van giving extra driving confidence to anyone new to motorhome travel. Complete with a sleek exterior and a stylish, modern interior, it's filled with all the travelling essentials and more.



## 3 layouts

-  2 - 4 berths
-  3500kg MTPLM
-  Drivable on standard Cat B licence









# Ascari

## Quick View

**344** 



**Belts | Berths**  
4 | 4



**Length**  
5.99m / 19' 8"





**Width**  
2.26m / 7' 5"



**MTPLM | Payload**  
3500kg | 647kg



**372** 



**Belts | Berths**  
4 | 2



**Length**  
6.65m / 21' 10"





**Width**  
2.26m / 7' 5"

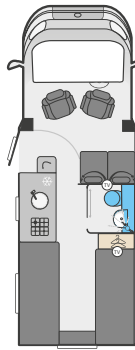

**MTPLM | Payload**  
3500kg | 595kg



**384** 



**Belts | Berths**  
4 | 3



**Length**  
6.99m / 22' 11"



**Width**  
2.26m / 7' 5"



**MTPLM | Payload**  
3500kg | 500kg

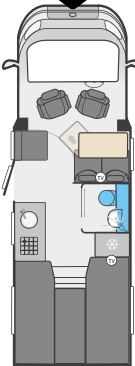

**Note:** The Ascari comes with a manual gear box as standard, the payload figure will decrease by 20kg if you select an automatic gear box option.







# Ascari Highlights

- 01. NEW** Fiat chassis cab in Lanzarote Grey, with updated front grille and body coloured bumper. Plus, **NEW** Euro 6E 140bhp, 2.2 litre engine
- 02.** SMART construction with full GRP bodyshell, including full GRP rear panel with exclusive LED rear light clusters
- 03.** Reversing camera with 7" LCD screen rear view mirror
- 04. NEW** 10" touchscreen HD colour display, DAB radio with Apple Carplay™ / Android Auto™, USB, Bluetooth and **NEW** Fiat Sat Nav with TomTom visualisation and selectable vehicle dimensions
- 05.** Panoramic opening sunroof to flood the interior with daylight
- 06.** River soft furnishing scheme featuring stain resistant, Aquaclean and Ultraleather easy to clean fabrics. Plus, Stylish locker construction with Vohringer door in Sangallo Elm woodgrain, graphite strip and cream gloss lower section with concealed handles
- 07.** High performance, durable foam in seats and backrests for greater seating and sleeping comfort
- 08.** Pleated four-sided cassette blinds with flyscreens on all windows
- 09. NEW** oven with grill, plus three-burner gas hob and stainless steel sink with glass lid and integrated tap

- 10.** Microwave oven with digital controls and under counter Dometic (Series 8) 90 litre manual energy selection fridge (tall, slimline 133 litre fridge in 384)
- 11.** Exclusive Duvalay Duvalite Alto mattresses, which includes a platinum support layer and reflex foam for superior durability (344 & 384)
- 12.** Lounge bench seat cushions and bed mattresses supported by beech slats for extra comfort
- 13.** User-friendly EC400 Control unit with battery selection, battery level meter, lighting control and water system controls
- 14.** Dual fuel Truma Combi boiler and Truma 'Crash Sensor Mono' regulator for en-route use of heating and water heating
- 15.** A minimum of four chrome 230V sockets and increased dedicated USB points including under locker USB points



## Find out more

For the full details, visit the Ascari page on our website by scanning the QR code or by visiting [swiftgroup.co.uk/ascari](http://swiftgroup.co.uk/ascari)





# Introducing Voyager

Built on a Ford chassis for travelling peace of mind, the award winning Voyager has been designed for families who love to explore. With a refined and sleek interior, Voyager maximises space without compromising on design or on-board amenities.



## 10 layouts

 4 - 6 berths

 3500kg MTPLM\*

 Drivable on standard Cat B licence

\*Based on standard specification. Weight increases above 3500kg when adding auto gear box to 475 and 485 models. Auto options available at 3500kg with four travelling seats





# Voyager

## Quick View

**Note:** The Voyager comes with a manual gear box as standard. If you choose an automatic option, the payload will decrease by 30kg - Figure based on an MTPLM of 3500kg across the range.

\*Estimate

**475**



**Belts | Berths**  
5 | 5



**Length**  
7.54m / 24' 9"



**Width**  
2.37m / 7' 9"



**MTPLM | Payload**  
3500kg | 430kg

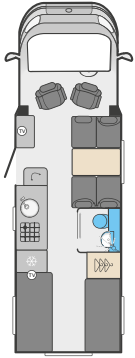

**485**



**Belts | Berths**  
5 | 5



**Length**  
7.54m / 24' 9"



**Width**  
2.37m / 7' 9"



**MTPLM | Payload**  
3500kg | 430kg

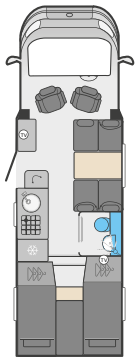

**494**



**Belts | Berths**  
4 | 4



**Length**  
7.54m / 24' 9"



**Width**  
2.37m / 7' 9"



**MTPLM | Payload**  
3500kg | 412kg

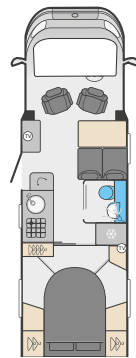

**505 NEW**



**Belts | Berths**  
2 | 4



**Length**  
6.19m / 20' 4"



**Width**  
2.37m / 7' 9"



**MTPLM | Payload**  
3500kg | 670kg\*

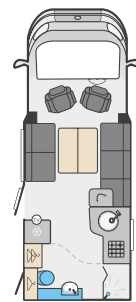

**510 NEW**



**Belts | Berths**  
4 | 4



**Length**  
6.19m / 20' 4"



**Width**  
2.37m / 7' 9"



**MTPLM | Payload**  
3500kg | 640kg

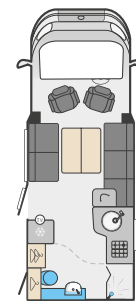

**540**



**Belts | Berths**  
4 | 4



**Length**  
7.01m / 23' 0"



**Width**  
2.37m / 7' 9"



**MTPLM | Payload**  
3500kg | 495kg

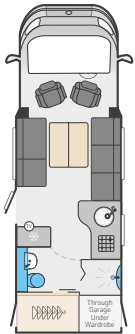

**564**



**Belts | Berths**  
4 | 4



**Length**  
7.22m / 23' 8"



**Width**  
2.37m / 7' 9"



**MTPLM | Payload**  
3500kg | 510kg

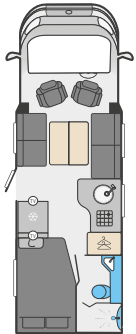

**574**



**Belts | Berths**  
4 | 6



**Length**  
7.73m / 25' 4"



**Width**  
2.37m / 7' 9"



**MTPLM | Payload**  
3500kg | 385kg

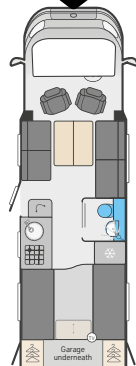

**584**



**Belts | Berths**  
4 | 4



**Length**  
7.85m / 25' 9"



**Width**  
2.37m / 7' 9"



**MTPLM | Payload**  
3500kg | 424kg

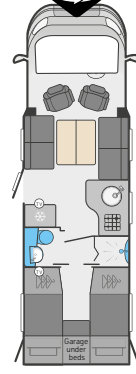

**594**



**Belts | Berths**  
4 | 4



**Length**  
7.85m / 25' 9"



**Width**  
2.37m / 7' 9"



**MTPLM | Payload**  
3500kg | 405kg

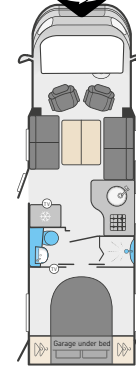





# Voyager Highlights

- 01. NEW** Ford Transit Skeletal chassis cab in Magnetic Grey with a **NEW** Euro 6E 130bhp, 2.0 litre TDCi EcoBlue engine with 6-speed manual transmission
- 02.** Ten models featuring distinctive streamlined aerodynamic profiles; GRP front highline pod with side window (4 Series) and GRP lowline pod (5 Series)
- 03.** SMART construction with full GRP rear panel, low LED lighting and **NEW** striking exterior graphics scheme coordinated with cab
- 04.** Dashboard design, including **NEW** 12" Ford Sync 4 featuring DAB/FM RDS Radio with Apple Carplay™ / Android Auto™, USB, Bluetooth and reversing camera image
- 05.** Cruise control for a more comfortable driving experience
- 06.** Rear reversing camera for added convenience
- 07. NEW** Jet soft furnishing scheme featuring high performance, durable seating throughout for relaxing and sleeping comfort with backrest ventilation boards and decorative Sangallo Elm woodgrain detail
- 08.** Pleated cassette blinds with flyscreens on all tinted acrylic, double glazed windows
- 09.** Slate Weft laminate kitchen worktop with textured finish and durable stainless steel sink with chrome mixer tap

- 10.** Thetford Triplex combination oven and grill, plus a three-burner gas hob with electric hotplate, all with electronic ignition. Hob features a glass lid with automatic gas shut-off functionality
- 11.** Dometic (Series 10) 133 litre, tall slimline, automatic energy selection fridge with 230V, gas and 12V operation incorporating 12 litre removable freezer compartment
- 12.** Exclusive Duvalay Duvalite Alto mattress for a good night's sleep (fixed beds, drop down beds and Luton beds)
- 13.** Dual fuel Truma combi boiler for excellent heating efficiency
- 14.** User-friendly EC400 control unit with battery selection, battery level meter, lighting control and water system controls
- 15.** FordPass Connect for added peace of mind, providing features such as remote locking and unlocking your vehicle, checking its last location, viewing the health status and more



## Find out more

For the full details, visit the Voyager page on our website by scanning the QR code or by visiting [swiftgroup.co.uk/voyager](http://swiftgroup.co.uk/voyager)



# Introducing Escape

The highly popular Swift Escape maintains its contemporary design and desirable features. It includes Aguti travel seats, sleek furniture, a boutique-style washroom, and exclusive Duvalay mattresses on fixed and drop down beds, providing a premium finish for discerning motorhome owners.



## 4 layouts

 4 - 6 berths

 3500kg - 4500kg MTPLM

 1 model drivable on standard  
Cat B licence











# Escape Quick View

**640** 

 **360°**

 **Belts | Berths**  
4 | 4

 **Length**  
6.99m / 22'11"

 **Width**  
2.37m / 7'9"

 **MTPLM | Payload**  
3500kg | 395kg

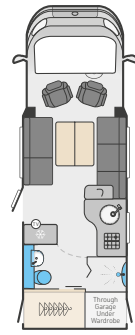



**674** 

 **360°**

 **Belts | Berths**  
5 | 6

 **Length**  
8.22m / 27'0"

 **Width**  
2.37m / 7'9"

 **MTPLM | Payload**  
4500kg | 1095kg

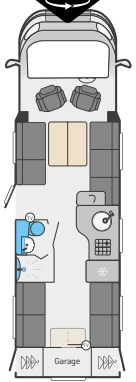



**684** 

 **360°**

 **Belts | Berths**  
4 | 4

 **Length**  
7.84m / 25'9"

 **Width**  
2.37m / 7'9"

 **MTPLM | Payload**  
3700kg | 480kg

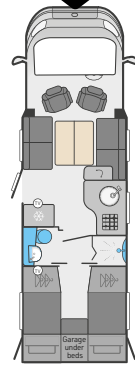



**694** 

 **360°**

 **Belts | Berths**  
4 | 4

 **Length**  
7.84m / 25'9"

 **Width**  
2.37m / 7'9"

 **MTPLM | Payload**  
3700kg | 485kg

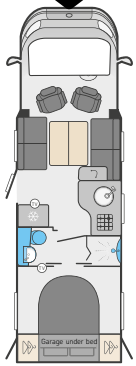





# Escape Highlights

- 01. NEW** Fiat chassis cab in Iron Grey Metallic, with **NEW** updated front grille and body coloured bumper with **NEW** Euro 6E 140bhp auto, 2.2 litre engine (180bhp auto in 674)
- 02.** Rear garage with lighting, heating, sockets and hanging provision, with access doors on both sides
- 03.** SMART construction with full GRP bodyshell and ample LED exterior lighting, including high-level brake light, for better visibility
- 04. NEW** 10" touchscreen HD colour display, DAB radio with Apple Carplay™ / Android Auto™, USB, Bluetooth and **NEW** Fiat Sat Nav with TomTom visualisation and selectable vehicle dimensions
- 05.** Reversing camera with 7" LCD screen rear view mirror, cruise control and steering wheel control for added convenience
- 06. NEW** Acacia soft furnishing scheme with complementary scatter cushions
- 07.** Cream gloss upper locker doors with feature inlays and decorative Sangallo Elm woodgrain detail with complementary Oxford TAJET, Toro Tela and Grau furniture
- 08.** Fold-down Auguti travelling seats incorporating ISOfix that fold down to create a front parallel lounge
- 09.** Ergonomically contoured bedding and sumptuous fabrics for increased comfort

- 10.** Exclusive Duvalay Duvalite Alto mattress for a more comfortable sleep (fixed and drop down beds)
- 11.** Slate Weft laminate kitchen worktop with textured finish and durable stainless steel sink with illuminated Beige Weft laminate kitchen splashback. Plus Dometic flatbed microwave. Plus, Thetford Triplex combination oven and grill, plus a three-burner gas hob with electric hotplate, all with electronic ignition. Hob features a glass lid with automatic gas shut-off functionality
- 12.** Dometic (Series 10) 133 litre dual hinged fridge
- 13.** Washroom design, including Crema Bianca marble effect wallboard, concrete effect sidewall GRP and quadrant lighting in separate shower cubicle
- 14.** Alde dual fuel radiator central heating and water heating with daily programming on LCD control panel with 1kW, 2kW or 3kW settings
- 15. NEW** 120W solar panel and regulator plus ultra-low energy lighting throughout, including LED downlights and illuminated grab handle



## Find out more

For the full details, visit the Escape page on our website by scanning the QR code or by visiting [swiftgroup.co.uk/escape](http://swiftgroup.co.uk/escape)





# Introducing Kon-Tiki

Kon-Tiki exudes glamour with its sleek lines, impeccable finishes and atmospheric lighting. The tactile Ultraleather® Cinnamon soft furnishing scheme creates a luxurious finish while the Aguti travelling seats offer practical yet stylish versatility.



## 6 layouts

-  4 - 6 berths
-  4500kg - 5000kg MTPLM
-  All models require a Cat C driving licence









# Kon-Tiki

## Quick View

**774** 



**Belts | Berths**  
5 | 6

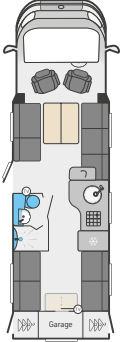



**Length**  
8.22m / 27' 0"



**Width**  
2.38m / 7'10"

**MTPLM | Payload**  
4500kg | 895kg

**784** 



**Belts | Berths**  
4 | 4





**Length**  
7.84m / 25'9"

**Width**  
2.38m / 7'10"

**MTPLM | Payload**  
4500kg | 1072kg

**794** 



**Belts | Berths**  
4 | 4

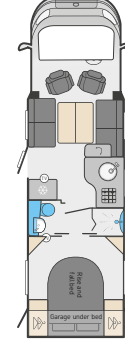



**Length**  
8.22m / 27' 0"

**Width**  
2.38m / 7'10"

**MTPLM | Payload**  
4500kg | 947kg

**874** 



**Belts | Berths**  
5 | 6

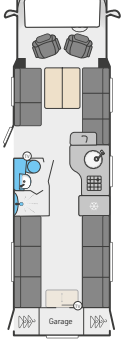



**Length**  
8.96m / 29'5"

**Width**  
2.38m / 7'10"

**MTPLM | Payload**  
5000kg | 1025kg

**884\*** 



**Belts | Berths**  
4 | 4

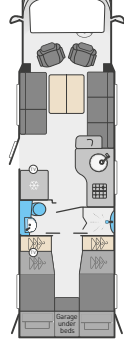



**Length**  
8.96m / 29'5"

**Width**  
2.38m / 7'10"

**MTPLM | Payload**  
5000kg | 1127kg

**894\*** 

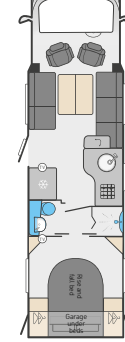

**Belts | Berths**  
4 | 4

**Length**  
8.96m / 29'5"

**Width**  
2.38m / 7'10"

**MTPLM | Payload**  
5000kg | 1117kg

\* Drop bed option in place of lockers over front lounge (884 & 894)





# Kon-Tiki Highlights

- 01. NEW** Fiat chassis cab in Black Metallic, with **NEW** updated front grille and body coloured bumper. Plus, **NEW** Euro 6E 180bhp auto, 2.2 litre engine
- 02.** SMART construction with full GRP bodyshell and ample LED exterior lighting, including high-level brake light, for better visibility
- 03.** Extensive storage including rear garage with lighting, heating, sockets and hanging provision, with access doors on both sides, plus two pull-out underfloor pannier lockers designed to store utility items
- 04.** Dashboard design with 10" touchscreen HD colour display, incorporating DAB radio with Apple Carplay™/Android Auto™. Plus, Fiat Sat Nav with TomTom visualisation and selectable vehicle dimensions
- 05.** Twin colour reversing cameras with 7" LCD screen rear view mirror and rear reversing sensors for a smoother parking experience
- 06. NEW** Indulgent Ultraleather® Cinnamon soft furnishing scheme designed with ultimate softness and durability and complementary scatter cushions
- 07.** Decorative Sangallo Elm woodgrain detailing and Cream/Pearl gloss, soft-close upper locker doors with dual chrome inlays
- 08.** Fold-down Aguti travelling seats incorporating ISOfix that convert to create a front parallel lounge, plus a Mapa electric rise and fall table

- 09.** Thetford thermostatic oven and separate grill, plus a three-burner hob, electric hotplate and Dometic flatbed microwave
- 10.** Dometic (10 series) 133L or 177L dual hinged fridge with freezer compartment
- 11.** Exclusive Duvalay Duvalite Alto mattress offering superior comfort and durability
- 12.** Washroom design including Crema Bianca marble effect wallboard and concrete effect sidewall GRP in separate shower cubicle
- 13.** Control and monitor on board systems with the 7" LCD colour touchscreen Command panel with improved user interface and functionality
- 14.** Alde dual fuel radiator central heating and water heating with daily programming on LCD control panel with 1kW, 2kW or 3kW settings, plus en-route heating
- 15.** 120W solar panel (two 100W panels on 874, 884 & 894) plus ultra-low energy lighting throughout, including LED downlights and illuminated grab handles



## Find out more

For the full details, visit the Kon-Tiki page on our website by scanning the QR code or by visiting [swiftgroup.co.uk/kon-tiki](http://swiftgroup.co.uk/kon-tiki)



# Layouts at a glance

When selecting the ideal motorhome layout, it's crucial to prioritise functionality and comfort to ensure a fulfilling travel experience. Start by considering the number of travellers and their individual preferences, including sleeping arrangements and desired amenities.

Front lounge layouts offer versatile seating and sleeping options, making them suitable for couples or small families seeking adaptability. Alternatively, rear lounge configurations provide expansive living areas with panoramic views, ideal for those prioritising relaxation and scenic enjoyment.

Island bed and corner bed designs prioritise easy access and comfort, while drop down beds optimise space without compromising lounge areas.

Classic motorhomes emphasise manoeuvrability and everyday usability, making them ideal for adventurers seeking versatility.

Assess storage options, bathroom and kitchen facilities, and overall liveability to find the perfect layout tailored to your unique travel preferences and needs, enhancing your journey with comfort and convenience.



- F** Front lounge bed
- D** Drop down bed
- I** Island bed
- C** Corner bed
- R** Rear lounge bed
- S\*** Single bed(s)
- LU** Luton bed
-  Drivable on standard licence

\*Option to convert the 2 single beds into a double bed.





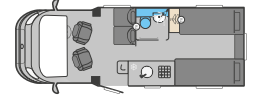

## Ascari

2 berths

372 |   





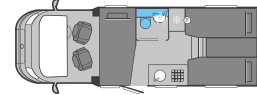

3 berths

384 |    



4 berths

344 |    

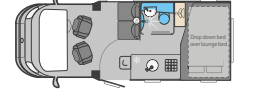

5 berths

344 |    



6 berths

344 |   





# Voyager

# Escape

# Kon-Tiki

494 | 4 seats | LU I

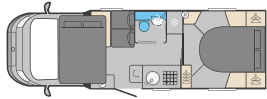

564 | 4 seats | F C

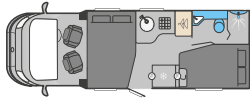

505 / 510 | 4 seats / 5 seats | F D

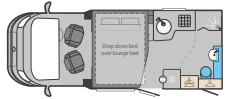

584 | 4 seats | F S



540 | 4 seats | F D

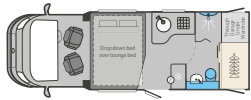

594 | 4 seats | F I

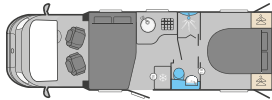

475 | 5 seats | LU S R

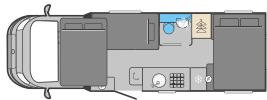

485 | 5 seats | LU S

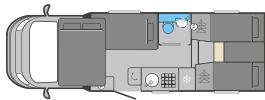

574 | 5 seats | F R D

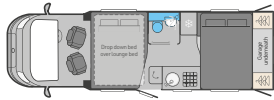

640 | 4 seats | F D

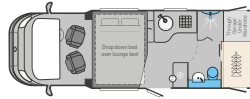

684 | 4 seats | F S



694 | 4 seats | F I

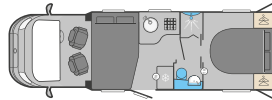

784 | 4 seats | F S

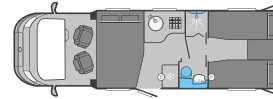

794 | 4 seats | F I

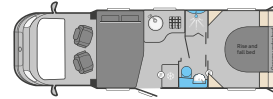

884 | 4 seats | F S

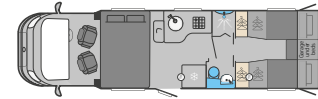

894 | 4 seats | F I

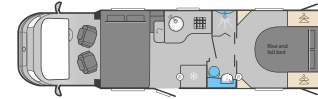

674 | 5 seats | F R D



774 | 5 seats | F R D

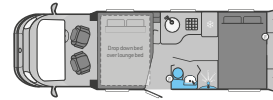

874 | 5 seats | F R D



# Fabrics at a glance

We use research, insights and trends to keep ahead of the designs that appeal to both today's and tomorrow's customers. We take the time to understand what designs appeal to you and your holiday lifestyle.

Today's trends involve a higher degree of ecological and environmental decisions, and at Swift, we share these values in our design and manufacturing decisions. We aim to replicate the natural world in colour and material choices within all of our products.

Keeping on top of the trends, through observation and research, we have seen a change in how our leisure vehicles are used. They are now more than just a place to relax and holiday, they also offer a home office space, where leisure and work can now comfortably mix, creating a new design vision and consideration for our motorhomes of the future.

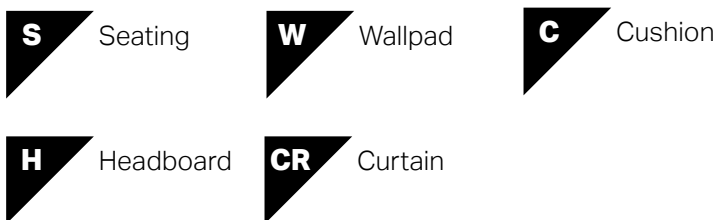

## Ascari

The Ascari range is fitted with the contemporary River fabric scheme, which has cool grey tones for a calming interior.

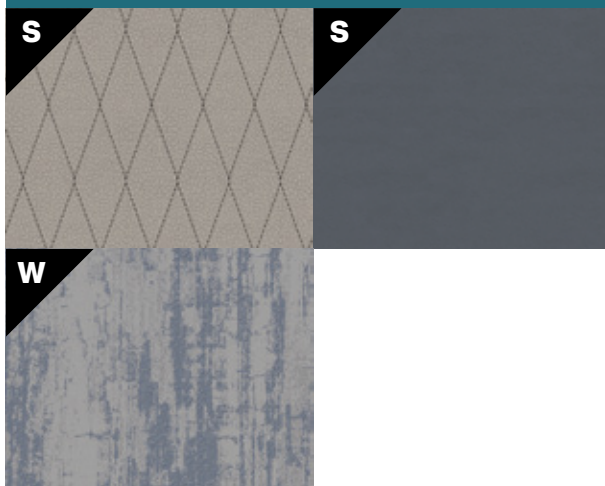

## Voyager

The Voyager range is fitted with the Jet soft furnishing scheme which have stain resistant properties and are easy to clean.

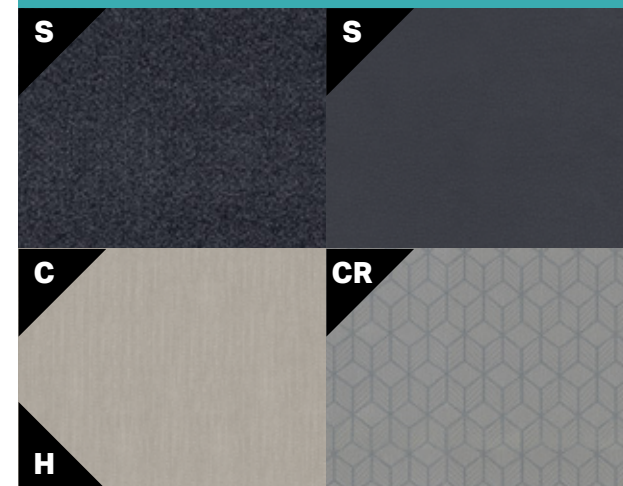



## Escape

The Escape range is fitted with the stain resistant, easy to clean Acacia soft furnishing scheme. Its light stone colour evokes a natural ambience.

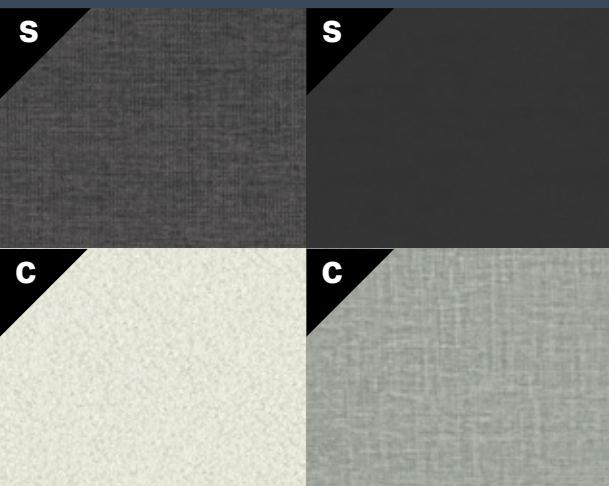

## Kon-Tiki

The Kon-Tiki range is fitted with the Ultraleather® Cinnamon soft furnishing scheme. This cream vegan leather is easy to clean and stain resistant, combining style and practicality.

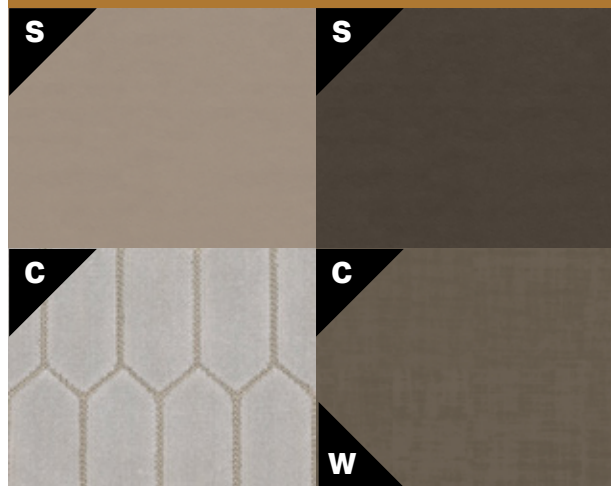

# aquaclean<sup>®</sup>

fabrics for living

At Swift, we believe holidays should be about relaxation and unforgettable memories. That's why we enhance our motorhomes with Aquaclean® technology\* - a revolutionary fabric treatment that keeps your upholstery pristine with minimal effort.

### Why Aquaclean®?

Aquaclean® technology lets you clean stains using only water. Easily wipe away wine, ink, sauce, and mud without harsh chemicals. This advanced protector ensures dirt stays on the surface, making clean-up a breeze and giving you more time to enjoy your travels.

### Stress-free holidays

During cozy family dinners or spontaneous snacks, Aquaclean® keeps your motorhome's upholstery spotless. Spend less time cleaning and more time enjoying the open road and quality moments with loved ones.

### See how it works!

Scan the QR code to watch a demo given by Aquaclean® Sales manager, James Lowe.



\* Does not apply to Kon-tiki, which is instead equipped with stain resistant ultraleather

# Specification at a glance

1. The Maximum User Payload includes:
  - a. the conventional load (this is the allowance for passengers)
  - b. essential habitation equipment (items and fluids required for safe and proper functioning of habitation equipment)
  - c. optional equipment (items available from the manufacturer over and above the standard specification)
  - d. personal effects (those items not covered by the above)
2. The Mass in Running Order is the mass of the unladen vehicle including a 75kg allowance for the driver plus engine coolants and 90% of the fuel tank capacity and 1 x 6kg Calor Lite LPG cylinder.
3. The MRO is calculated with the fresh water tank empty. If you travel with water in the fresh water tank then the payload will reduce accordingly.

	Cab	Standard Engine	Optional Auto Engine	Engine Capacity	Engine Torque	Rear Axles	Wheel Base	Seat Belts	Berths	Overall Length	Overall Width	Overall Height	Awning Size	Licence Required
<b>Ascari</b>														
<b>344</b>	Fiat	140 Bhp	140 Bhp Auto	2.2ltr	350Nm†	1	3.80m	4	4	5.99m	2.26m	2.78m	Thule T4200 3.0m	Cat B
<b>372</b>	Fiat	140 Bhp	140 Bhp Auto	2.2ltr	350Nm†	1	3.80m	4	2	6.65m	2.26m	2.78m	Thule T4200 4.0m	Cat B
<b>384</b>	Fiat	140 Bhp	140 Bhp Auto	2.2ltr	350Nm†	1	3.80m	4	3	6.99m	2.26m	2.80m	Thule T4200 4.0m	Cat B
<b>Voyager</b>														
<b>475</b>	Ford	130 Bhp	165 Bhp Auto <sup>+</sup>	2.0ltr	360Nm	1	4.52m	5	5	7.54m	2.37m	2.98m	Thule T4200 4.0m <sup>^</sup>	Cat B
<b>485</b>	Ford	130 Bhp	165 Bhp Auto <sup>+</sup>	2.0ltr	360Nm	1	4.52m	5	5	7.54m	2.37m	2.98m	Thule T4200 4.0m <sup>^</sup>	Cat B
<b>494</b>	Ford	130 Bhp	165 Bhp Auto	2.0ltr	360Nm	1	4.52m	4	4	7.54m	2.37m	2.98m	Thule T4200 4.0m <sup>^</sup>	Cat B
<b>505</b>	Ford	130 Bhp	165 Bhp Auto	2.0ltr	360Nm	1	3.95m	2	4	6.19m	2.37m	2.87m	Thule T4200 3.0m <sup>^</sup>	Cat B
<b>510</b>	Ford	130 Bhp	165 Bhp Auto	2.0ltr	360Nm	1	3.95m	4	4	6.19m	2.37m	2.87m	Thule T4200 3.0m <sup>^</sup>	Cat B
<b>540</b>	Ford	130 Bhp	165 Bhp Auto	2.0ltr	360Nm	1	3.95m	4	4	7.01m	2.37m	2.86m	Thule T4200 4.0m <sup>^</sup>	Cat B
<b>564</b>	Ford	130 Bhp	165 Bhp Auto	2.0ltr	360Nm	1	3.95m	4	4	7.22m	2.37m	2.86m	Thule T4200 4.0m <sup>^</sup>	Cat B
<b>574</b>	Ford	130 Bhp	165 Bhp Auto	2.0ltr	360Nm	1	4.52m	4	6	7.73m	2.37m	2.87m	Thule T4200 4.5m <sup>^</sup>	Cat B
<b>584</b>	Ford	130 Bhp	165 Bhp Auto	2.0ltr	360Nm	1	4.52m	4	4	7.85m	2.37m	2.87m	Thule T4200 4.5m <sup>^</sup>	Cat B
<b>594</b>	Ford	130 Bhp	165 Bhp Auto	2.0ltr	360Nm	1	4.52m	4	4	7.85m	2.37m	2.87m	Thule T4200 4.5m <sup>^</sup>	Cat B
<b>Escape</b>														
<b>640</b>	Fiat	140 Bhp Auto	N/A	2.2ltr	380Nm	1	4.20m	4	4	6.99m	2.37m	2.86m	Thule T4200 4.0m	Cat B
<b>674</b>	Fiat	180 Bhp Auto	N/A	2.2ltr	450Nm	1	4.70m	5	6	8.22m	2.37m	2.86m*	Thule T4200 4.5m	Cat C
<b>684</b>	Fiat	140 Bhp Auto	N/A	2.2ltr	380Nm	1	4.70m	4	4	7.84m	2.37m	2.88m	Thule T4200 4.5m	Cat C
<b>694</b>	Fiat	140 Bhp Auto	N/A	2.2ltr	380Nm	1	4.70m	4	4	7.84m	2.37m	2.88m	Thule T4200 4.5m	Cat C
<b>Kon-Tiki</b>														
<b>774</b>	Fiat	180 Bhp Auto	N/A	2.2ltr	450Nm	1	4.70m	5	6	8.22m	2.38m	2.87m	Thule T4200 4.5m	Cat C
<b>784</b>	Fiat	180 Bhp Auto	N/A	2.2ltr	450Nm	1	4.70m	4	4	7.84m	2.38m	2.89m	Thule T4200 4.5m	Cat C
<b>794</b>	Fiat	180 Bhp Auto	N/A	2.2ltr	450Nm	1	4.70m	4	4	8.22m	2.38m	2.89m	Thule T4200 4.5m	Cat C
<b>874</b>	Fiat	180 Bhp Auto	N/A	2.2ltr	450Nm	2	4.70m / 0.80m	5	6	8.96m	2.38m	2.87m	Thule T4200 4.5m	Cat C
<b>884</b>	Fiat	180 Bhp Auto	N/A	2.2ltr	450Nm	2	4.70m / 0.80m	4	4	8.96m	2.38m	2.89m	Thule T4200 4.5m	Cat C
<b>894</b>	Fiat	180 Bhp Auto	N/A	2.2ltr	450Nm	2	4.70m / 0.80m	4	4	8.96m	2.38m	2.89m	Thule T4200 4.5m	Cat C



4. Please take care to ensure that you have allowed for the masses of all items you intend to carry in the motorhome, e.g. passengers, optional equipment, essential habitation equipment and personal effects, such as clothing, food, pets, bicycles, sailboards, sports equipment etc.
5. **Warning - under no circumstances should the maximum technical permissible laden mass of the motorhome be exceeded.**

6. Caution - When fitting a tow bar, it must meet certain minimum requirements as specified by Type Approval Regulations. The bar will have marked on it the approval standard (94/20/EC or 55R ECE) and the maximum download, or nose weight, that it can accept. It must fit the manufacturer's approved mounting points and must not obscure the towing vehicle's number plate.
7. Note - the additional weight of the tow bar and trailer nose weight increases the rear axle loading of the motorhome so

care should be taken that the rear axle load is not exceeded when towing.

# The maximum trailer weight is limited by the gross train weight which must not be exceeded. For example if the vehicle is at the maximum MTPLM of 3700kg, then the maximum trailer weight possible is 1800kg. Reducing the weight of the vehicle by removing payload, will allow you to increase the trailer weight up to a maximum of 2000kg. If you are unsure please check with your local dealer the towing capacity of your vehicle.

† Torque increases to 380Nm on automatic options. MRO increases by 20kg on automatic options. Payload decreases by 20kg on automatic options.

‡ MRO increases by 30kg on automatic options. Payload decreases by 30kg on automatic options with a standard MTPLM of 3500kg.

\*Estimate ^Option \*\*Requires annual subscription

+Based on standard specification. Weight increases above 3500kg when adding auto gear box to 475 and 485 models. Auto options available at 3500kg with four travelling seats

	Standard MTPLM	Standard MRO	Standard Max User Payload	Standard Max Trailer Weight	Standard Gross Train Weight	Thermal Insulation Grade	Heating System	Cab Screen Display	Wireless Phone Charging	External Electric Socket	Gas BBQ Point	External Cold Water Shower Point	Swift Command	Swift Command Tracker**
<b>Ascari</b>														
<b>344</b>	3500kg	2853kg <sup>†</sup>	647kg <sup>†</sup>	2000kg	5500kg	THREE	Truma	10"	✓	✓	✓	✓	x	x
<b>372</b>	3500kg	2905kg <sup>†</sup>	595kg <sup>†</sup>	2000kg	5500kg	THREE	Truma	10"	✓	✓	✓	✓	x	x
<b>384</b>	3500kg	3000kg <sup>†</sup>	500kg <sup>†</sup>	2000kg	5500kg	THREE	Truma	10"	✓	✓	✓	✓	x	x
<b>Voyager</b>														
<b>475</b>	3500kg	3070kg <sup>‡</sup>	430kg <sup>‡</sup>	2000kg	5500kg	THREE	Truma	12"	✓	✓	✓	✓	x	x
<b>485</b>	3500kg	3070kg <sup>‡</sup>	430kg <sup>‡</sup>	2000kg	5500kg	THREE	Truma	12"	✓	✓	✓	✓	x	x
<b>494</b>	3500kg	3088kg <sup>‡</sup>	412kg <sup>‡</sup>	2000kg	5500kg	THREE	Truma	12"	✓	✓	✓	✓	x	x
<b>505</b>	3500kg	2830kg <sup>**</sup>	670kg <sup>**</sup>	2000kg	5500kg	THREE	Truma	12"	✓	✓	✓	✓	x	x
<b>510</b>	3500kg	2860kg <sup>‡</sup>	640kg <sup>‡</sup>	2000kg	5500kg	THREE	Truma	12"	✓	✓	✓	✓	x	x
<b>540</b>	3500kg	3005kg <sup>‡</sup>	495kg <sup>‡</sup>	2000kg	5500kg	THREE	Truma	12"	✓	✓	✓	✓	x	x
<b>564</b>	3500kg	2990kg <sup>‡</sup>	510kg <sup>‡</sup>	2000kg	5500kg	THREE	Truma	12"	✓	✓	✓	✓	x	x
<b>574</b>	3500kg	3115kg <sup>‡</sup>	385kg <sup>‡</sup>	2000kg	5500kg	THREE	Truma	12"	✓	✓	✓	✓	x	x
<b>584</b>	3500kg	3076kg <sup>‡</sup>	424kg <sup>‡</sup>	2000kg	5500kg	THREE	Truma	12"	✓	✓	✓	✓	x	x
<b>594</b>	3500kg	3095kg <sup>‡</sup>	405kg <sup>‡</sup>	2000kg	5500kg	THREE	Truma	12"	✓	✓	✓	✓	x	x
<b>Escape</b>														
<b>640</b>	3500kg	3105kg	395kg	2000kg	5500kg	THREE	Alde	10"	✓	x	✓	✓	x	x
<b>674</b>	4500kg	3405kg	1095kg	2000kg <sup>#</sup>	6000kg <sup>#</sup>	THREE	Alde	10"	✓	✓	✓	✓	x	x
<b>684</b>	3700kg	3220kg	480kg	2000kg <sup>#</sup>	5500kg <sup>#</sup>	THREE	Alde	10"	✓	✓	✓	✓	x	x
<b>694</b>	3700kg	3215kg	485kg	2000kg <sup>#</sup>	5500kg <sup>#</sup>	THREE	Alde	10"	✓	✓	✓	✓	x	x
<b>Kon-Tiki</b>														
<b>774</b>	4500kg	3605kg	895kg	2000kg <sup>#</sup>	6000kg <sup>#</sup>	THREE	Alde	10"	✓	✓	✓	✓	✓	✓
<b>784</b>	4500kg	3428kg	1072kg	2000kg <sup>#</sup>	6000kg <sup>#</sup>	THREE	Alde	10"	✓	✓	✓	✓	✓	✓
<b>794</b>	4500kg	3553kg	947kg	2000kg <sup>#</sup>	6000kg <sup>#</sup>	THREE	Alde	10"	✓	✓	✓	✓	✓	✓
<b>874</b>	5000kg	3975kg	1025kg	2000kg <sup>#</sup>	6000kg <sup>#</sup>	THREE	Alde	10"	✓	✓	✓	✓	✓	✓
<b>884</b>	5000kg	3873kg	1127kg	2000kg <sup>#</sup>	6000kg <sup>#</sup>	THREE	Alde	10"	✓	✓	✓	✓	✓	✓
<b>894</b>	5000kg	3883kg	1117kg	2000kg <sup>#</sup>	6000kg <sup>#</sup>	THREE	Alde	10"	✓	✓	✓	✓	✓	✓

# Bed sizes at a glance

	Front Double	Front Single	Rear Double	Rear Offside Single	Rear Nearside Single	Drop Down Bed	Luton Bed
<b>Ascari</b>							
344			6'4" x 3'11"			6'1" x 3'10"	
372			6'4" x 6'0"	6'0 x 2'3"	6'5" x 2'3"		
384		6'3" x 3'0"/1'10"		6'0 x 2'5"	6'5" x 2'5"		
<b>Voyager</b>							
475		6'4" x 3'3"	6'7" x 4'10"				6'3" x 4'4"
485		6'4" x 3'3"	6'9" x 3'9"	6'3" x 2'7"	6'3" x 2'7"		6'3" x 4'4"
494			6'0" x 4'8"				6'3" x 4'4"
505	6'4" x 5'10" / 3'9"					6'2" x 4'11"	
510	6'4" x 5'10" / 3'9"					6'2" x 4'11"	
540	6'4" x 5'10" / 3'9"					6'2" x 4'11"	
564	6'4" x 4'4" / 3'5"		6'2" x 4'3"				
574	6'4" x 5'10" / 3'9"		6'8" x 4'4"			6'2" x 4'11"	
584	6'4" x 4'4" / 3'5"		6'9" x 3'9"	6'5" x 2'7"	6'5" x 2'7"		
594	6'4" x 4'4" / 3'5"		6'0" x 4'8"				
<b>Escape</b>							
640	6'4" x 5'10" / 4'6"					6'2" x 4'11"	
674	6'4" x 4'6"		6'8" x 4'4"			6'2" x 4'11"	
684	6'4" x 4'4" / 3'6"		6'9" x 3'9"	6'5" x 2'7"	6'5" x 2'7"		
694	6'4" x 4'4" / 3'6"		6'0" x 4'8"				
<b>Kon-Tiki</b>							
774	6'4" x 4'6"		6'8" x 4'4"			6'2" x 4'11"	
784	6'4" x 4'4" / 3'6"		6'9" x 3'9"	6'5" x 2'7"	6'5" x 2'7"		
794	6'4" x 4'4" / 3'6"		5'11" x 4'8"				
874	6'4" x 4'11" / 4'6"		6'8" x 6'0"			6'2" x 4'11"	
884	6'4" x 6'1" / 4'11"		6'9" x 3'9"	6'5" x 2'7"	6'5" x 2'7"		
894	6'4" x 6'1" / 4'11"		6'5" x 4'8"				





# TRY BEFORE YOU BUY WITH SWIFT GO

## Not sure which Swift Motorhome is right for you?

The open road. The freedom to explore new places. The sense of adventure. There are lots of reasons why people choose Swift motorhomes. Now you can enjoy an even more rewarding break with Swift Go motorhome hire.

Try before you buy and we'll refund up to 7 nights' hire off the final purchase price.

T&Cs apply - see website for full details

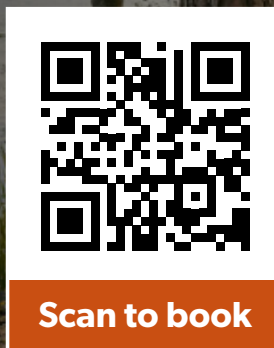

- At Swift Go we promise...
- One price
  - No hidden extras
  - Includes free Wi-Fi
  - Additional drivers included
  - All you need as standard
  - Flexible hiring
  - Pet friendly





**SWIFT**

**COMMAND**

DEVELOPED WITH SARGENT

## More control with **Swift Command**

Only available with our Kon-Tiki range, Swift Command monitors and controls the onboard systems via a touch screen panel and a smartphone app, so you can always be in control.

With the convenience of your mobile device, you can access the onboard interface using Bluetooth when near your motorhome or via your internet connection when remote.

Swift Command enables you to track system levels such as power, temperature, and humidity, and monitor the location of your vehicle. You can even control the heating, activating it for a warm return on colder days.

The app also lets you set up notifications to keep you informed of important functions, such as battery levels, frost alerts and alarm status.

Head to the Apple or Android store and search for 'Swift Command'.

 Download on the  
**App Store**

ANDROID APP ON  
 **Google play**



For even greater peace of mind, you can subscribe to the Thatcham Category S7 approved pro-active tracker to add extra security to your vehicle.

Swift Command Tracker by Sargent is monitored by an approved monitoring centre which operates 24 hours a day 7 days a week and provides European coverage and direct police liaison. This system is ready for use, all you need to do is purchase a tracking subscription by visiting [www.swiftcommand.co.uk](http://www.swiftcommand.co.uk) or calling Sargent on 01482 881655.





### Lighting

Create just the right ambience onboard with easily adjustable lighting settings.



### Location and remote features

Connect to your leisure vehicle from anywhere to view its systems information and location.

Conveniently control and monitor your onboard services when away from your vehicle.



### Water

Keep an eye on your precious water levels so you know in good time when to top-up.



### Heating

Activate whilst out exploring and enjoy the warmth when you get back.



### Power

Track your energy use and manage your batteries for efficient use of your all important power services.



### Fridge

Track your energy use and manage your batteries for efficient use of your all important power services.



**SWIFT**

*My Swift Life*

## Get personal with **My Swift Life**

My Swift Life\* provides owners with a unique personal profile, where you can access information that's specific to your caravan, campervan or motorhome, including; outstanding warranty claims, service information and a direct line into our Swift customer experience team.

Log in to My Swift Life and report faults directly to Swift, enabling us to work together and allowing us to respond more quickly to your needs. Our new platform hosts a variety of information, including product notifications, customer bulletins, product recalls and upgrades, as well as important notifications about our products and services.

Using My Swift Life, you can also view chargeable orders that have been placed on your behalf, by your Swift dealer or servicing provider, along with any outstanding warranty claims from the date of ownership.

What's more, you'll have access to useful tips and our comprehensive "How To" video library, designed to help you familiarise yourself with your Swift caravan, campervan or motorhome.

\* Available to UK registered customers only.

### **Join My Swift Life for all this and more!**

- Access to useful "How To" video guides
- Access to personalised information 24/7
- Ability to report faults directly to our customer care team
- Authorised claims passed directly to dealer to speed up the warranty process
- Product upgrades notifications
- Live messaging direct into Swift's customer experience retail team, including direct access to technical support
- Upload service history records
- Service history reminders
- Useful bulletins and alerts

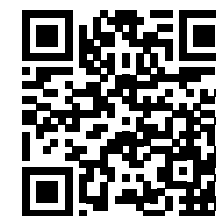

### **Find out more**

Scan this QR code to see all of what My Swift Life has to offer.



Join the club!

# Swift owners clubs

## Swift Motorhome Owners Club

We are a group of like minded people who meet up throughout the year at rallies held by the Club.

Some rallies coincide with National Motorhome Shows, some take us to luxury campsites, others abroad - in short we aim to provide something for everyone.

Our members come from all walks of life, and all parts of the country. The 'vans' they own vary from large to small and from very new to very well used. The common bond between us is that we own a Swift Group motorhome or campervan. Membership of the club is open to anyone who is the owner of a Swift Group motorhome or campervan.

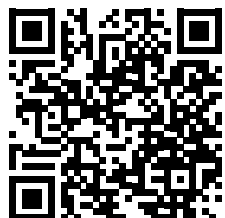

**Join up!**

Scan this QR code to find out more about joining the Swift Motorhome Owners Club

## Swift Owners Club

The Swift Owners Club is the natural home for owners of Swift Group caravans, campervans and motorhomes. Our members come from all walks of life and include families, couples, single and retired people. Everyone, including pets, are welcome!

Joining our Club offers a host of social benefits and is probably one of the best investments you could make. If your caravan, campervan or motorhome is a brand owned by the Swift Group, or is an Airstream caravan (model years 2017, 2018 or 2019), what are you waiting for?

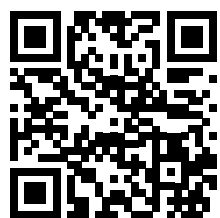

**Join up!**

Scan this QR code to find out more about joining the Swift Owners Club



Join the Swift community



Find out more at [swiftgroup.co.uk](https://www.swiftgroup.co.uk)

This brochure does not constitute an offer by Swift Group Limited (Swift). Swift reserves the right to alter specifications and prices at any time as materials and conditions demand. Distributors and dealers sell Swift products on their own account and not as agents of Swift. Accordingly, they have no authority to bind Swift or to make any representation or undertaking whatsoever on behalf of Swift. Please note, within this brochure, concept imagery may be used and therefore final specifications may be subject to change. Please confirm with your supplying dealer. All props are for photographic purposes only and are not included in the specification. Models shown may be fitted with optional extras. Issued September 2024.

